

# Arithmagons

Find the missing numbers by adding the corner circles to make the squares.

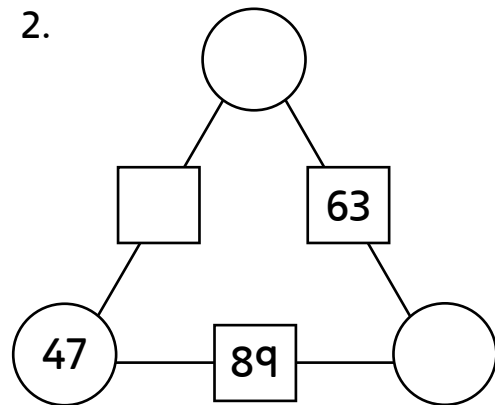

Find the missing numbers by multiplying the corner circles to make the squares.

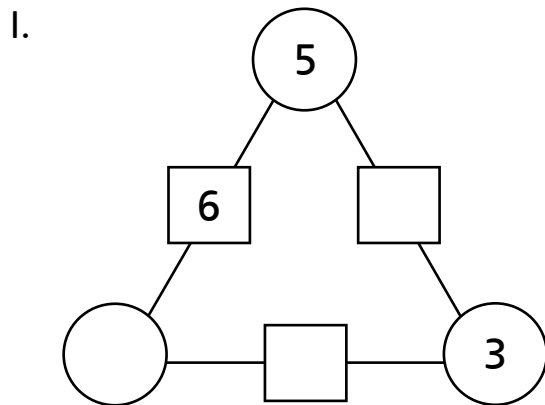
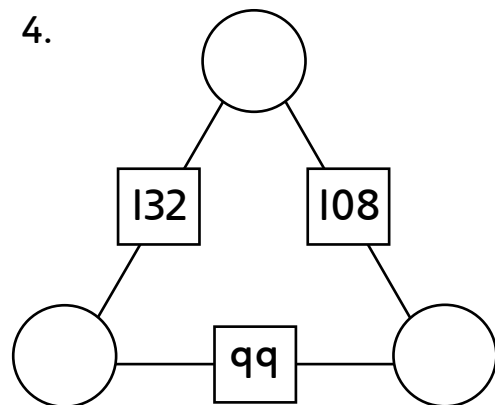
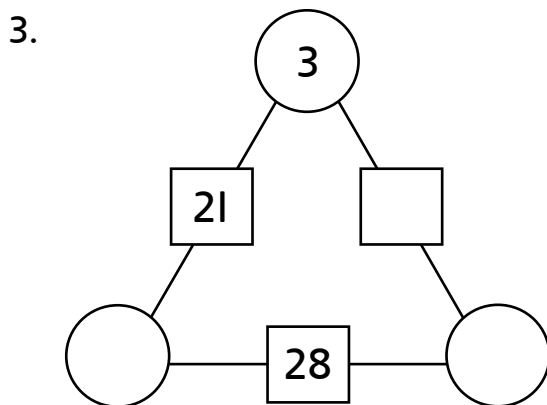

**Pyramids** Find the brick above by adding the two below.

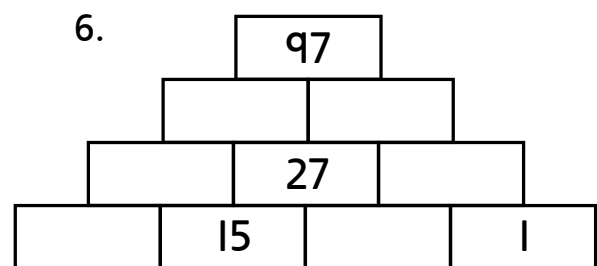
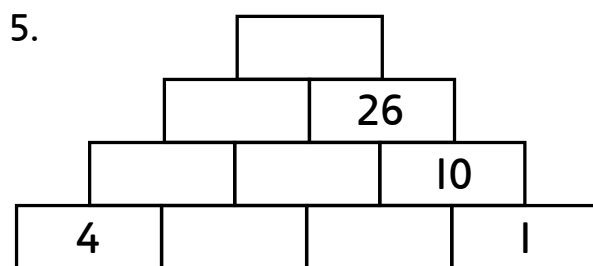

Find the brick above by multiplying the two below.

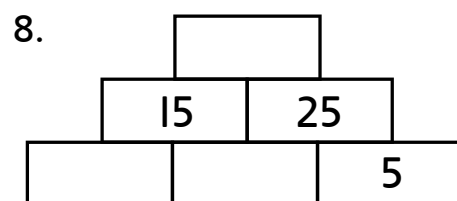
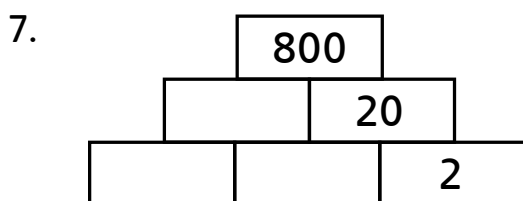

I can use inverse operations to solve problems.

