

FOR OFFICIAL USE

--	--	--	--	--	--

**X012/201**

Section B Total Marks

--

NATIONAL  
QUALIFICATIONS  
2009

WEDNESDAY, 3 JUNE  
9.00 AM – 11.00 AM

CHEMISTRY  
INTERMEDIATE 2

Fill in these boxes and read what is printed below.

Full name of centre

--

Town

--

Forename(s)

--

Surname

--

Date of birth

Day Month Year

--	--	--	--	--	--	--	--	--	--

Scottish candidate number

--	--	--	--	--	--	--	--	--	--

Number of seat

--

Necessary data will be found in the Chemistry Data Booklet for Standard Grade and Intermediate 2.

**Section A – Questions 1–30 (30 marks)**

Instructions for completion of **Section A** are given on page two.

For this section of the examination you must use an **HB pencil**.

**Section B (50 marks)**

All questions should be attempted.

The questions may be answered in any order but all answers are to be written in the spaces provided in this answer book, **and must be written clearly and legibly in ink**.

Rough work, if any should be necessary, should be written in this book, and then scored through when the fair copy has been written. If further space is required, a supplementary sheet for rough work may be obtained from the invigilator.

Additional space for answers will be found at the end of the book. If further space is required, supplementary sheets may be obtained from the invigilator and should be inserted inside the **front** cover of this booklet.

Before leaving the examination room you must give this book to the invigilator. If you do not, you may lose all the marks for this paper.



### Read carefully

- 1 Check that the answer sheet provided is for **Chemistry Intermediate 2 (Section A)**.
- 2 For this section of the examination you must use an **HB pencil** and, where necessary, an eraser.
- 3 Check that the answer sheet you have been given has **your name, date of birth, SCN** (Scottish Candidate Number) and **Centre Name** printed on it.  
Do not change any of these details.
- 4 If any of this information is wrong, tell the Invigilator immediately.
- 5 If this information is correct, **print** your name and seat number in the boxes provided.
- 6 The answer to each question is **either** A, B, C or D. Decide what your answer is, then, using your pencil, put a horizontal line in the space provided (see sample question below).
- 7 There is **only one correct** answer to each question.
- 8 Any rough working should be done on the question paper or the rough working sheet, **not** on your answer sheet.
- 9 At the end of the exam, put the **answer sheet for Section A inside the front cover of this answer book**.

### Sample Question

To show that the ink in a ball-pen consists of a mixture of dyes, the method of separation would be

- A chromatography
- B fractional distillation
- C fractional crystallisation
- D filtration.

The correct answer is **A**—chromatography. The answer **A** has been clearly marked in **pencil** with a horizontal line (see below).

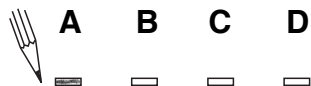

### Changing an answer

If you decide to change your answer, carefully erase your first answer and using your pencil, fill in the answer you want. The answer below has been changed to **D**.



SECTION A

1. Which of the following gases is a noble gas?

- A Argon
- B Oxygen
- C Fluorine
- D Nitrogen

2. Which line in the table correctly shows how the concentration of a solution changes by adding more solute or by adding more solvent?

	Adding solute	Adding solvent
A	concentration falls	concentration rises
B	concentration falls	concentration falls
C	concentration rises	concentration falls
D	concentration rises	concentration rises

3. Magnesium and zinc both react with hydrochloric acid.

In which of the following experiments would the reaction rate be fastest?

A

20°C  
1 mol l<sup>-1</sup> hydrochloric acid  
zinc lump

B

30°C  
2 mol l<sup>-1</sup> hydrochloric acid  
magnesium lump

C

30°C  
1 mol l<sup>-1</sup> hydrochloric acid  
zinc powder

D

40°C  
2 mol l<sup>-1</sup> hydrochloric acid  
magnesium powder

4. The table shows the numbers of protons, electrons and neutrons in four particles, **W**, **X**, **Y** and **Z**.

Particle	Protons	Electrons	Neutrons
<b>W</b>	17	17	18
<b>X</b>	11	11	12
<b>Y</b>	17	17	20
<b>Z</b>	18	18	18

Which pair of particles are isotopes?

- A **W** and **X**
- B **W** and **Y**
- C **X** and **Y**
- D **Y** and **Z**

5. When solid sodium chloride dissolves in water, a solution containing sodium ions and chloride ions is formed.

Which of the following equations correctly shows the state symbols for this process?

- A  $\text{NaCl(s)} + \text{H}_2\text{O(l)} \rightarrow \text{Na}^+(\text{l}) + \text{Cl}^-(\text{l})$
- B  $\text{NaCl(s)} + \text{H}_2\text{O(l)} \rightarrow \text{Na}^+(\text{aq}) + \text{Cl}^-(\text{aq})$
- C  $\text{NaCl(s)} + \text{H}_2\text{O(aq)} \rightarrow \text{Na}^+(\text{aq}) + \text{Cl}^-(\text{aq})$
- D  $\text{NaCl(aq)} + \text{H}_2\text{O(l)} \rightarrow \text{Na}^+(\text{aq}) + \text{Cl}^-(\text{aq})$

6. Metallic bonding is a force of attraction between

- A positive ions and delocalised electrons
- B negative ions and delocalised electrons
- C negative ions and positive ions
- D a shared pair of electrons and two nuclei.

[Turn over

7. The table gives information about the attraction some atoms have for bonded electrons.

Atom	Attraction for electrons
C	least ↓ greatest
I	
Br	
Cl	
F	

Which of the following bonds is the **least** polar?

- A C – F  
 B C – Cl  
 C C – Br  
 D C – I
8. Which of the following diagrams represents a **compound** made up of **diatomic** molecules?

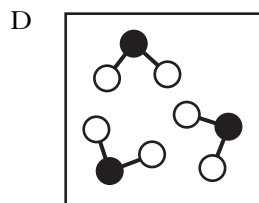
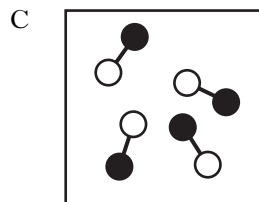
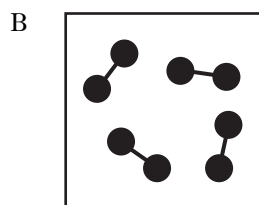
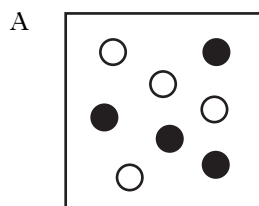

9. Which of the following diagrams could be used to represent the structure of sodium chloride?

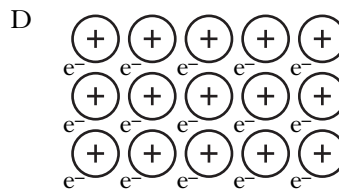
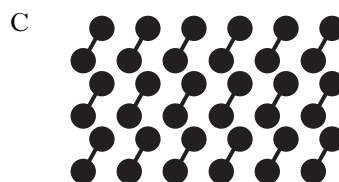
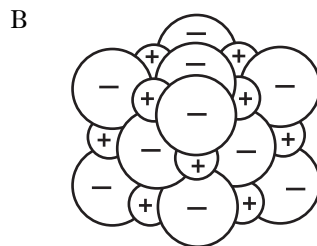
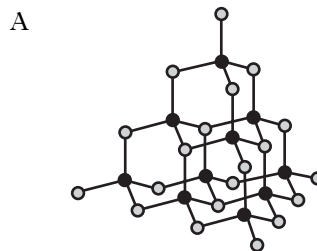

- 10.

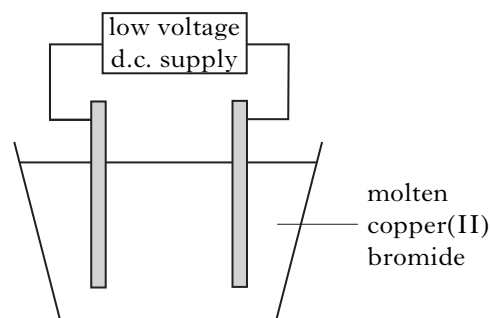

During the electrolysis of molten copper(II) bromide

- A copper atoms lose electrons to form copper ions  
 B bromine molecules gain electrons to form bromide ions  
 C bromide ions gain electrons to form bromine molecules  
 D copper ions gain electrons to form copper atoms.

11. What is the name of the compound with the formula  $\text{Ag}_2\text{O}$ ?

- A Silver(I) oxide
- B Silver(II) oxide
- C Silver(III) oxide
- D Silver(IV) oxide

12. Which of the following exhaust emissions is most likely to come from the incomplete combustion of diesel?

- A Water vapour
- B Soot particles
- C Carbon dioxide
- D Nitrogen dioxide

13. The apparatus shown can be used to identify what is produced when a gas is burned.

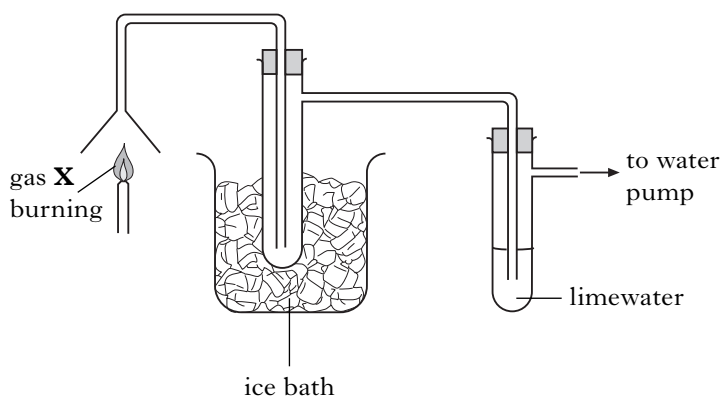

When gas **X** was burned, a colourless liquid collected in the cooled test tube but there was no change in the limewater.

Gas **X** could be

- A methane
- B carbon monoxide
- C hydrogen
- D ethene.

14. The fractional distillation of crude oil produces a number of different fractions.

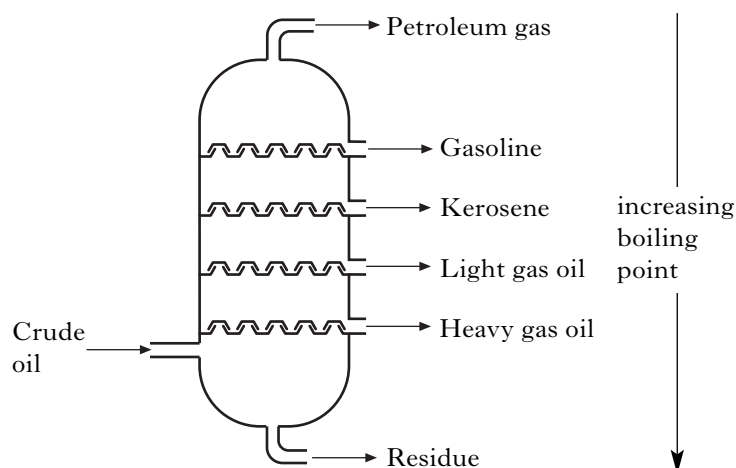

Compared with the heavy gas oil fraction, the kerosene fraction

- A is less flammable and contains larger hydrocarbon molecules
- B is less flammable and contains smaller hydrocarbon molecules
- C is more flammable and contains larger hydrocarbon molecules
- D is more flammable and contains smaller hydrocarbon molecules.

15. Which of the following could be the molecular formula of a cycloalkane?

- A  $\text{C}_7\text{H}_{10}$
- B  $\text{C}_7\text{H}_{12}$
- C  $\text{C}_7\text{H}_{14}$
- D  $\text{C}_7\text{H}_{16}$

**[Turn over**



18. Part of the structure of an addition polymer is shown below. It is made using two different monomers.

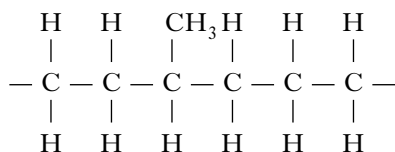

Which pair of alkenes could be used as monomers for this polymer?

- A Ethene and propene  
 B Ethene and butene  
 C Propene and butene  
 D Ethene and pentene
19. In which of the following experiments would **both** carbohydrates give an orange precipitate when heated with Benedict's solution?

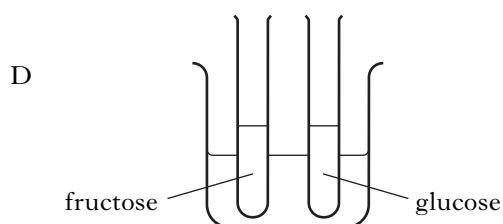
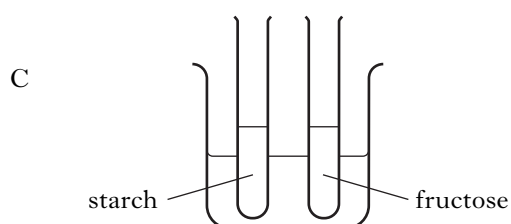
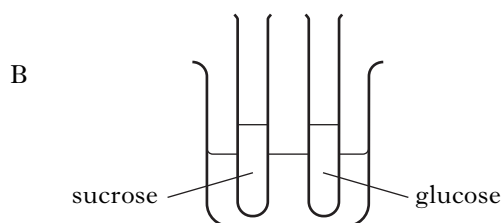
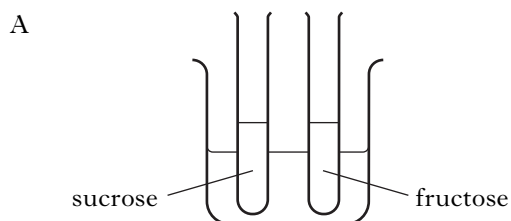

20. Glycerol can be obtained from a fat by
- A hydrolysis  
 B esterification  
 C condensation  
 D neutralisation.

21. Which oxide, when shaken with water, would leave the pH unchanged?

(You may wish to use page 5 of the data booklet to help you.)

- A Calcium oxide  
 B Carbon dioxide  
 C Sulphur dioxide  
 D Zinc oxide

22. Two tests were carried out on compound X.

**Test 1**

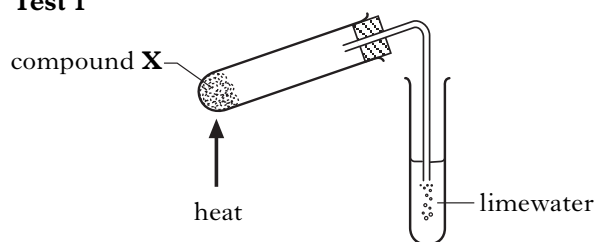

**Test 2**

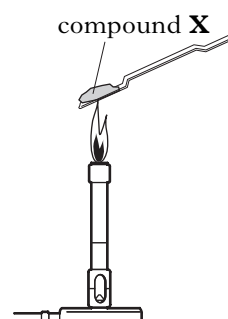

The following results were obtained.

Test	Result
1	limewater turns cloudy
2	flame turns blue-green

Which of the following could be compound X?

(You may wish to use page 4 of the data booklet to help you.)

- A Barium carbonate  
 B Copper carbonate  
 C Copper sulphate  
 D Sodium sulphate

23. Which line in the table correctly shows the properties of  $0.1 \text{ mol l}^{-1}$  ethanoic acid compared to  $0.1 \text{ mol l}^{-1}$  hydrochloric acid?

	pH	Conductivity	Rate of reaction with magnesium
A	higher	lower	slower
B	lower	higher	faster
C	higher	higher	faster
D	lower	lower	slower

24. In water, an equilibrium exists between water molecules and hydrogen and hydroxide ions.

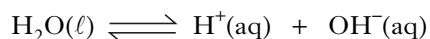

At equilibrium

- A the water molecules have stopped changing into ions  
 B the water molecules have all changed into ions  
 C the concentrations of water molecules and ions are equal  
 D the concentrations of water molecules and ions are constant.

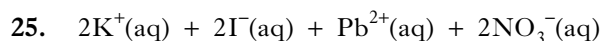

↓

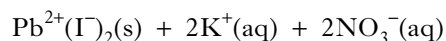

The type of reaction represented by the equation above is

- A addition  
 B neutralisation  
 C precipitation  
 D redox.

26. Which of the following diagrams shows the apparatus which would allow a soluble gas to be removed from a mixture of gases?

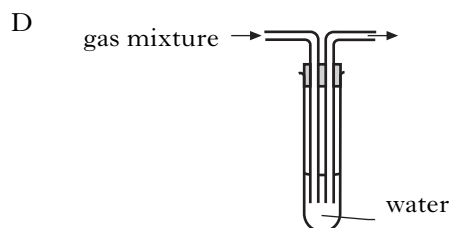
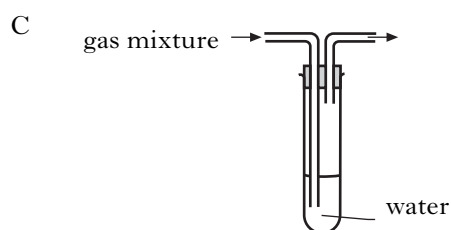
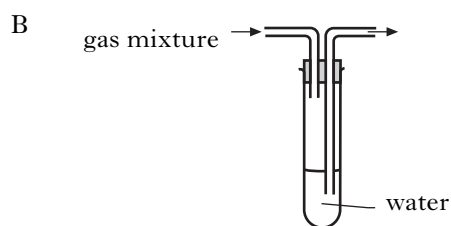
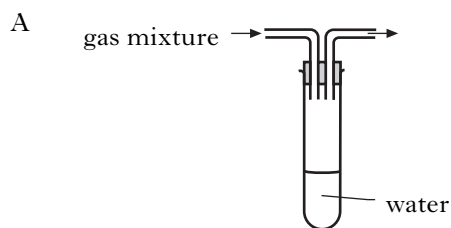



27. Which pair of metals, when connected in a cell, would give the highest voltage and a flow of electrons from **X** to **Y**?

(You may wish to use page 7 of the data booklet to help you.)

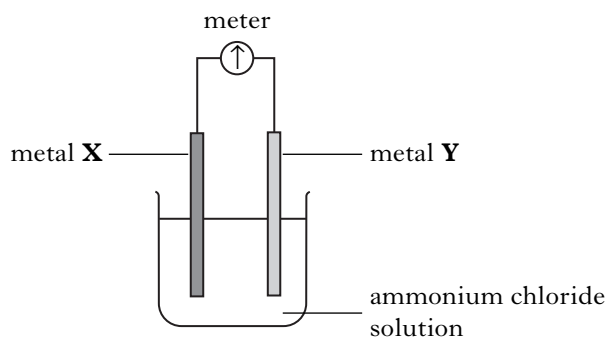

	Metal X	Metal Y
A	magnesium	copper
B	copper	magnesium
C	zinc	tin
D	tin	zinc

28. The ion-electron equation

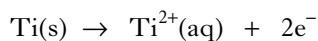

represents the

- A reduction of titanium atoms
- B reduction of titanium ions
- C oxidation of titanium atoms
- D oxidation of titanium ions.

29. The following statements relate to four different metals, **P**, **Q**, **R** and **S**.

Metal **P** displaces metal **Q** from a solution containing ions of **Q**.

In a cell, electrons flow from metal **S** to metal **P**.

Metal **R** is the only metal which can be obtained from its ore by heat alone.

The order of reactivity of the metals, starting with the **most** reactive is

- A **S, P, Q, R**
- B **R, Q, P, S**
- C **R, S, Q, P**
- D **S, Q, P, R.**

- 30.

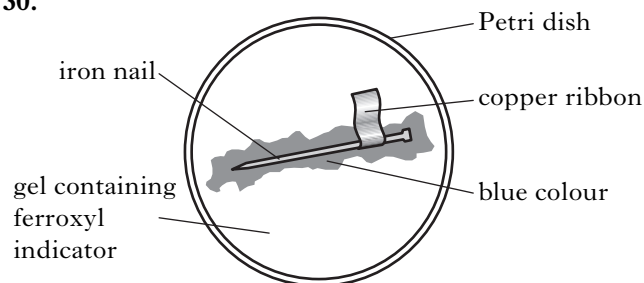

Which ion gives a blue colour with ferroxyl indicator?

- A  $\text{OH}^{-}(\text{aq})$
- B  $\text{Fe}^{2+}(\text{aq})$
- C  $\text{Fe}^{3+}(\text{aq})$
- D  $\text{Cu}^{2+}(\text{aq})$

**Candidates are reminded that the answer sheet for Section A MUST be placed INSIDE the front cover of this answer book.**

**[Turn over**

**[BLANK PAGE]**

## SECTION B

50 marks are available in this section of the paper.

All answers must be written clearly and legibly in ink.

1. Atoms contain particles called protons, neutrons and electrons.

The nuclide notation of the sodium atom is shown.



- (a) Complete the table to show the number of each type of particle in this sodium atom.

Particle	Number
electron	11
proton	
neutron	

1

- (b) Electrons are arranged in energy levels.

- (i) Complete the diagram to show how the electrons are arranged in a sodium atom.

(You may wish to use page 1 of the data booklet to help you.)

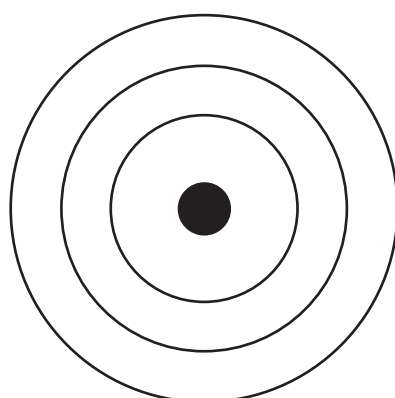

● = nucleus

X = electron

1

- (ii) Explain what holds the negatively charged electrons in place around the nucleus.

---



---

1

(3)

Marks

2. The diagram shows the apparatus used to prepare chlorine gas. Concentrated hydrochloric acid is reacted with potassium permanganate. The gas produced is bubbled through water to remove any unreacted hydrochloric acid and is then dried by bubbling through concentrated sulphuric acid.

- (a) Complete the diagram for the preparation of chlorine gas by adding the labels for concentrated sulphuric acid, potassium permanganate and water.

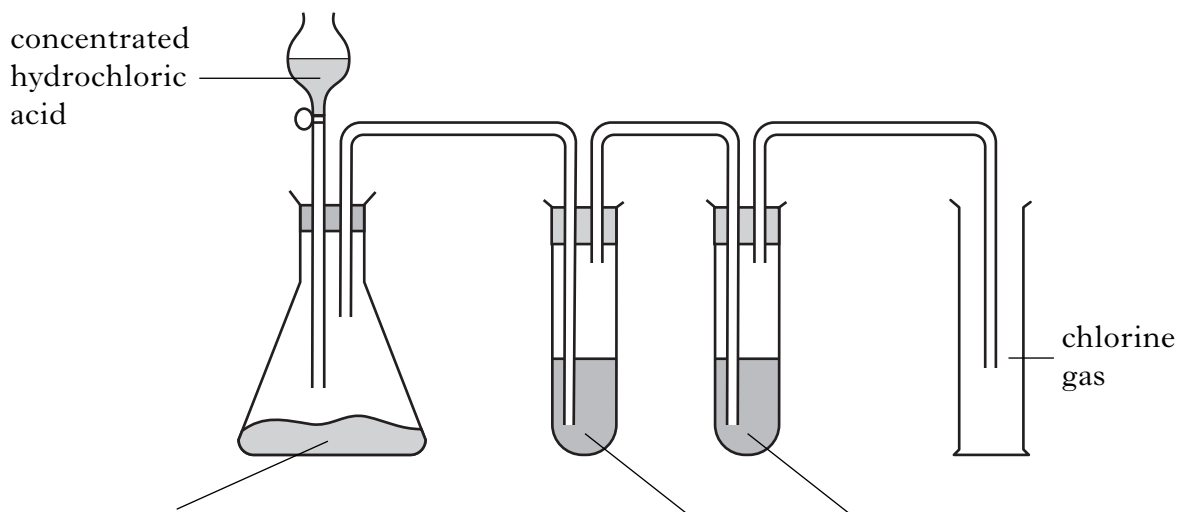

1

- (b) Chlorine is a member of the Group 7 elements.

The graph shows the melting points of these elements.

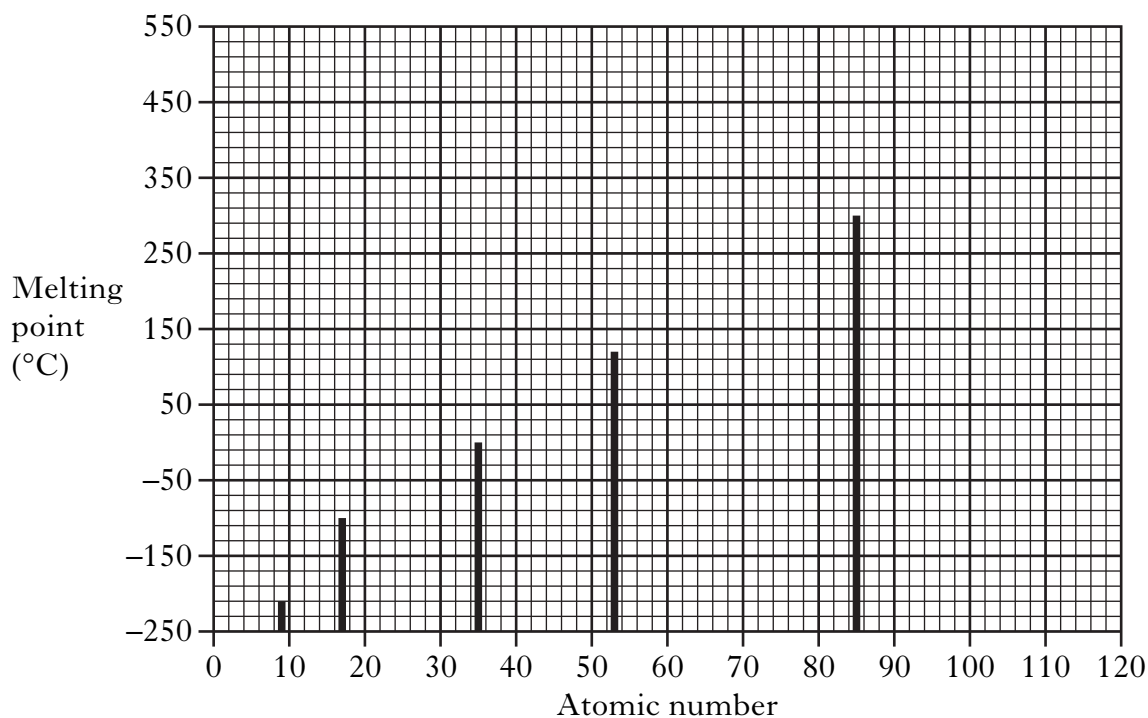

Marks

2. (b) (continued)

- (i) State the relationship between the atomic number and the melting point of the Group 7 elements.

---

---

---

1

- (ii) The next member of this group would have an atomic number of 117.

Using the graph, predict the melting point of this element.

Melting point \_\_\_\_\_ °C

1

(3)

[Turn over

Marks

3. When calcium chloride is dissolved in water, heat is released to the surroundings.

(a) What term is used to describe chemical reactions which give out heat?

\_\_\_\_\_

1

(b) A student investigated how changing the mass of calcium chloride affects the heat released.

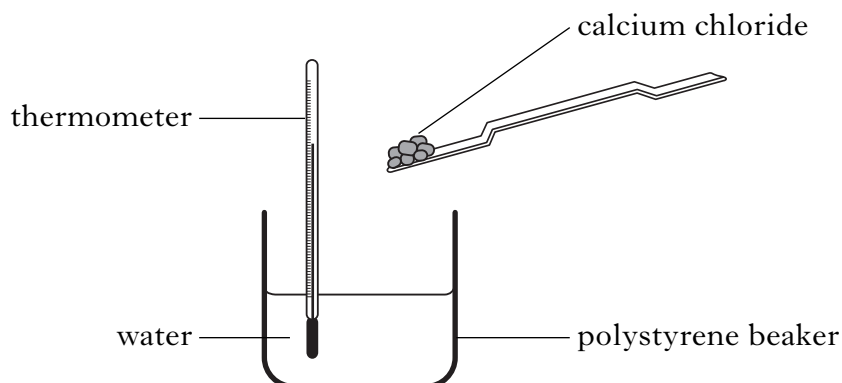

The results are shown.

Mass of calcium chloride used (g)	Highest temperature reached (°C)
0	20
5	28
10	34
15	41
20	50
25	57

Marks

3. (b) (continued)

(i) Plot a line graph of these results.

(Additional graph paper, if required, can be found on page 30.)

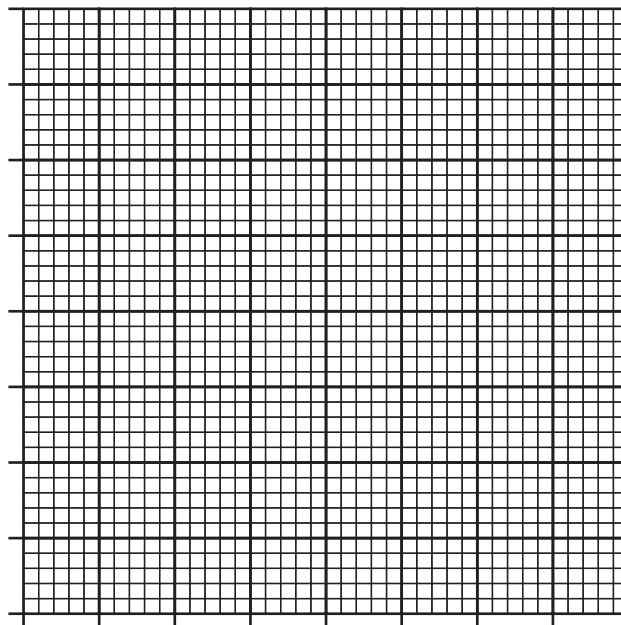

2

(ii) Using your graph, find the mass of calcium chloride that would give a temperature of 40 °C.

\_\_\_\_\_ g

1

(c) State an advantage of using a polystyrene beaker in this experiment.

\_\_\_\_\_  
\_\_\_\_\_

1

(5)

[Turn over

Marks

4. Iron is produced from iron ore in a Blast Furnace.

Zone	Key reaction
3	$\text{Fe}_2\text{O}_3(\text{s}) + \text{CO}(\text{g}) \rightarrow \text{Fe}(\text{l}) + \text{CO}_2(\text{g})$
2	$\text{CO}_2(\text{g}) + \text{C}(\text{s}) \rightarrow 2\text{CO}(\text{g})$
1	$\text{C}(\text{s}) + \text{O}_2(\text{g}) \rightarrow \text{CO}_2(\text{g})$

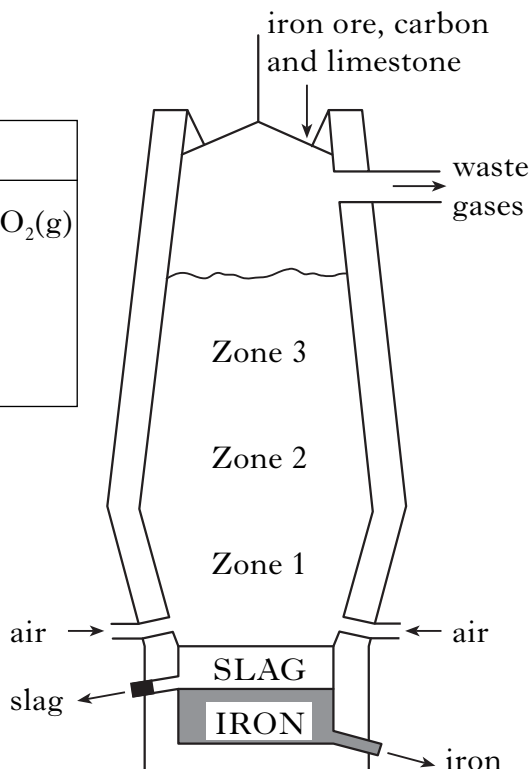

(a) The key reaction which takes place in Zone 3 is shown.

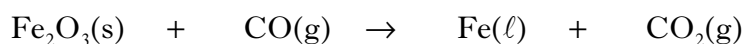

Balance this equation.

1

(b) The equation for the key reaction in Zone 2 is shown below. Calculate the mass of carbon monoxide produced when 1200 kg of carbon reacts.

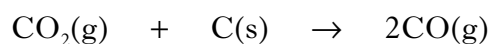

\_\_\_\_\_ kg

2

(c) Why is air blown into the Blast Furnace?

\_\_\_\_\_

1

(4)



Marks

5. Air is a mixture of gases. These gases can be separated by the process of fractional distillation.

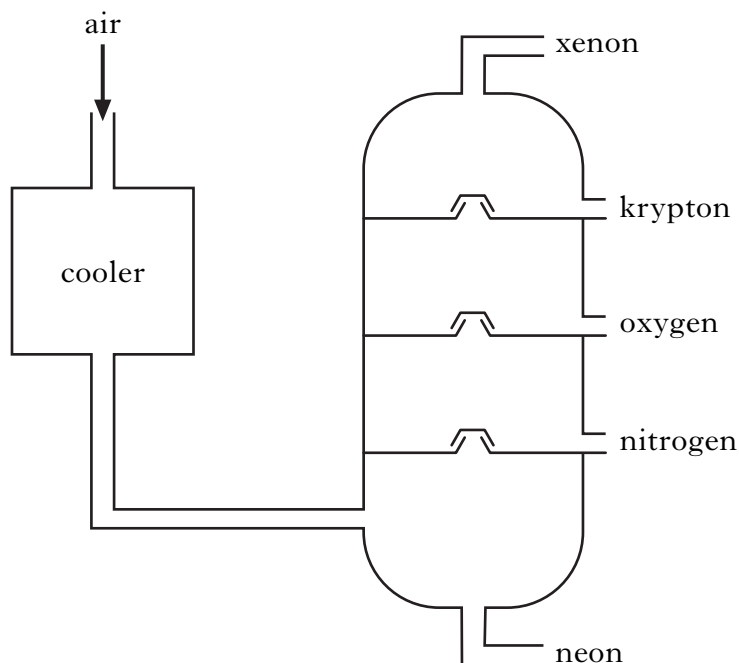

- (a) Why can these gases be separated by fractional distillation?

---

---

1

- (b) Nitrogen is separated from the mixture at  $-200\text{ }^{\circ}\text{C}$ .  
Circle the state that nitrogen will be in at this temperature.  
(You may wish to use page 3 of your data booklet to help you.)

solid                  liquid                  gas

1

- (c) The cooler contains sodium hydroxide solution. This reacts with the carbon dioxide in the air and removes it from the mixture of gases.  
Name the type of chemical reaction taking place.

---

1

(3)

**[Turn over**

Marks

6. The octane number of petrol is a measure of how efficiently it burns as a fuel. The higher the octane number, the more efficient the fuel.

(a) What is a fuel?

\_\_\_\_\_

**1**

(b) The octane numbers for some hydrocarbons are shown.

Hydrocarbon	Number of carbon atoms	Octane number
hexane	6	
heptane	7	0
octane	8	-19
2-methylpentane	6	71
2-methylhexane	7	44
2-methylheptane	8	23

(i) Predict the octane number for hexane.

\_\_\_\_\_

**1**

(ii) State a relationship between the structure of the hydrocarbon and their efficiency as fuels.

\_\_\_\_\_

\_\_\_\_\_

\_\_\_\_\_

**1****(3)**

Marks

7. The diagram shows how paraffin,  $C_{12}H_{26}$ , can be cracked.

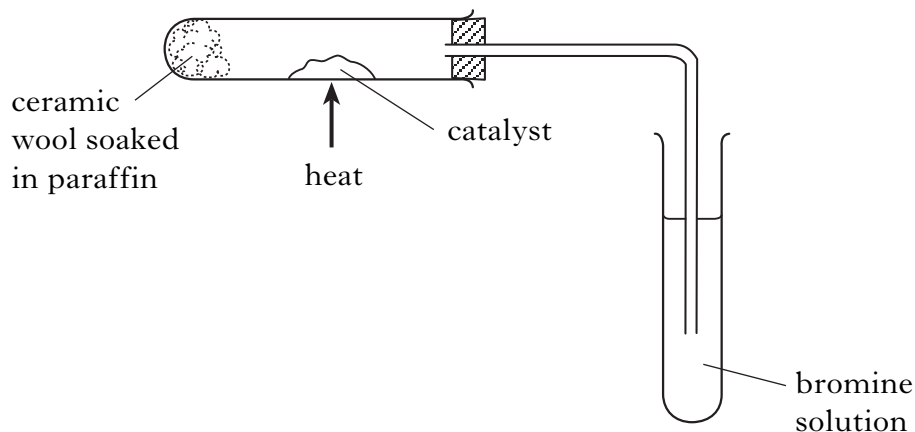

- (a) Name the catalyst used in cracking.

\_\_\_\_\_

1

- (b) One of the reactions taking place when paraffin is cracked is



- (i) Identify molecule **X**.

\_\_\_\_\_

1

- (ii) Describe what would be **seen** when **X** is added to bromine solution.

\_\_\_\_\_

\_\_\_\_\_

1

(3)

[Turn over

Marks

8. Alkynes are a homologous series of hydrocarbons which contain carbon to carbon triple bonds. Two members of this series are shown.

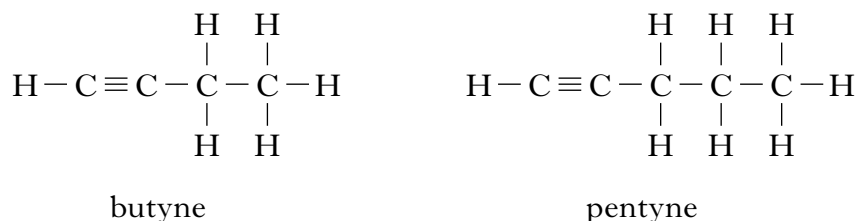

- (a) Name the first member of this series.

\_\_\_\_\_

1

- (b) Alkynes can be prepared by reacting a dibromoalkane with potassium hydroxide solution.

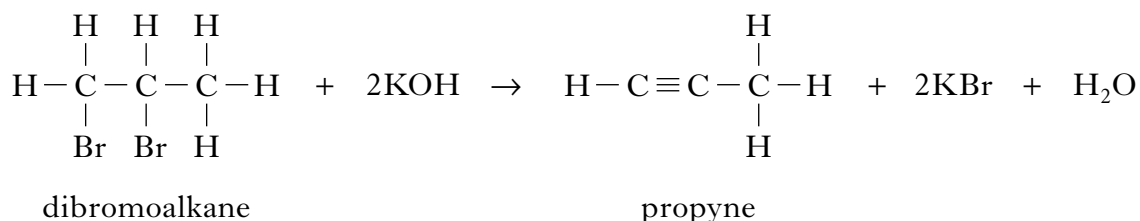

- (i) Draw a structural formula for the alkyne formed when the dibromoalkane shown reacts with potassium hydroxide solution.

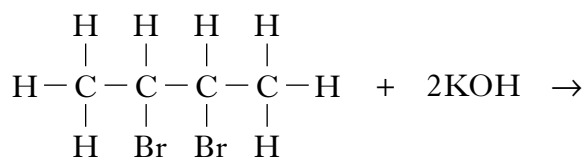

1

- (ii) Suggest a reason why the dibromoalkane shown below does not form an alkyne when it is added to potassium hydroxide solution.

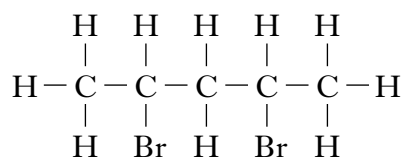

\_\_\_\_\_

\_\_\_\_\_

1

(3)

Marks

9. The enzyme RuBisCo is one of the most abundant enzymes on Earth. It contains lysine at its active site.

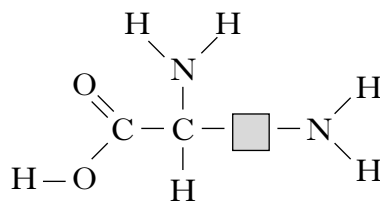

lysine

- (a) Lysine contains two different types of functional groups.  
Circle an amine group in the lysine molecule shown above. 1
- (b) Name the family of compounds to which lysine belongs.  
\_\_\_\_\_ 1
- (c) Complete the equation to show the structure of the other product formed when two molecules of lysine react.

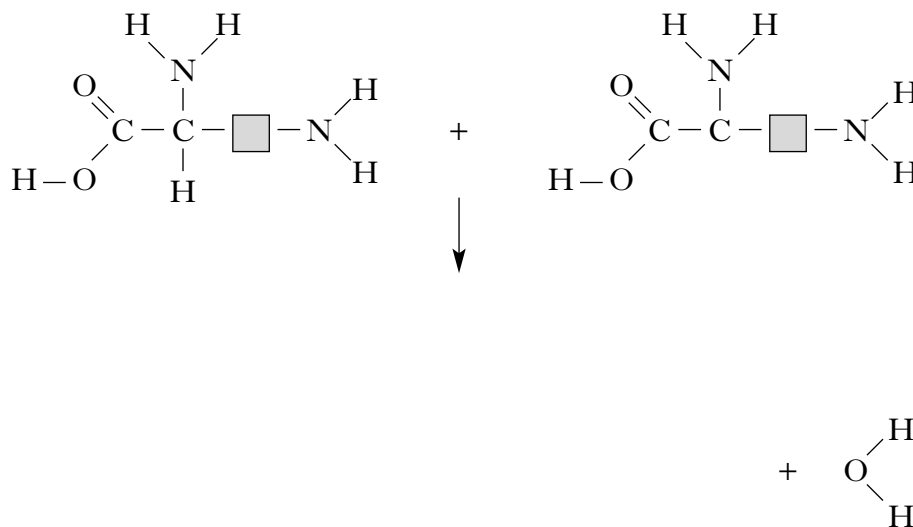

1  
(3)

[Turn over

Marks

10. The flow chart shows some of the stages in the manufacture of ethanoic acid.

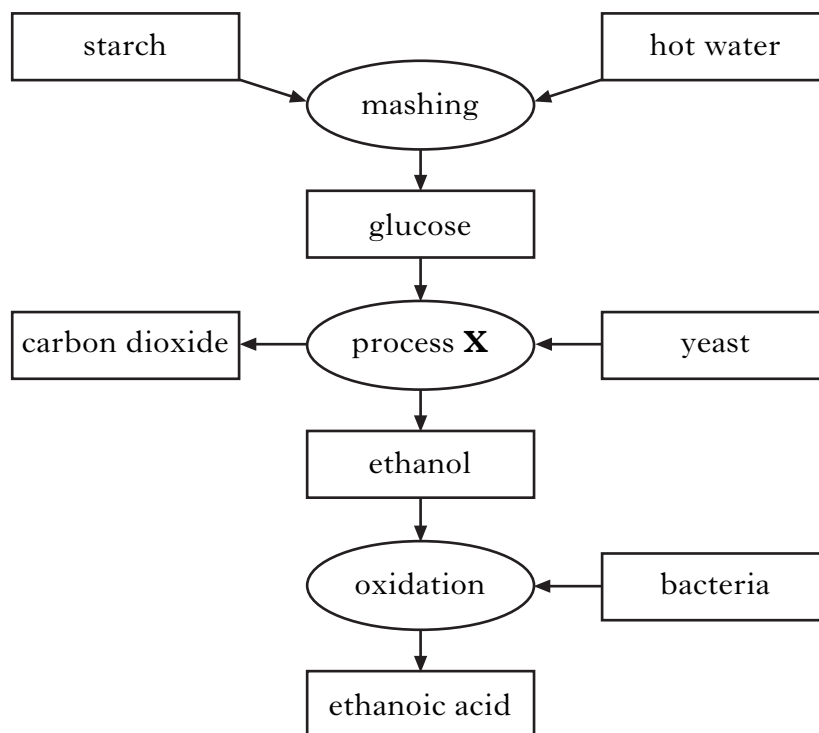

- (a) In the mashing process, some of the starch is broken down into glucose.

Using the flow chart, write the word equation for the reaction taking place in the mashing process.

\_\_\_\_\_ 1

- (b) Name process X.

\_\_\_\_\_ 1

- (c) Draw the full structural formula for ethanoic acid.

\_\_\_\_\_ 1

- (d) Ethanoic acid can be reacted with methanol to form an ester, which is used as a solvent in nail varnish remover.

Name this ester.

\_\_\_\_\_ 1

(4)

Marks

11. Urea is a substance found in human urine. The enzyme urease catalyses the hydrolysis of urea. During the reaction, ammonia and carbon dioxide are produced.

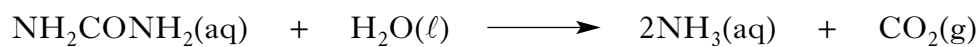

- (a) What is an enzyme?

---

1

- (b) The ammonia solution produced in this reaction is described as a weak base.

- (i) What is meant by a weak base?

---

---

1

- (ii) The concentration of ammonia solution can be determined as follows:

- 1 pipette 10 cm<sup>3</sup> of ammonia solution into a conical flask
- 2 add 3 drops of indicator solution
- 3 add 0.1 mol l<sup>-1</sup> of hydrochloric acid from a burette until the indicator changes colour

Name this technique.

---

1

(3)

**[Turn over**

Marks

12. Rhubarb contains oxalic acid,  $C_2H_2O_4$ . Oxalic acid decolourises acidified potassium permanganate solution.

An experiment was carried out to time how long it takes to decolourise the solution using different numbers of rhubarb cubes.

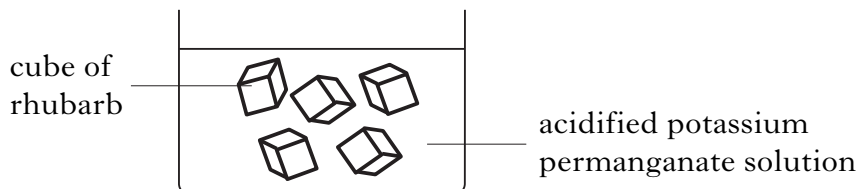

The results are shown.

Number of rhubarb cubes	Time to decolourise solution(s)	Relative rate (1/t) ( $s^{-1}$ )
5	360	0.003
10		0.006
15	92	0.011
20	40	0.025

- (a) Calculate the time taken for 10 cubes of rhubarb to decolourise the solution.

\_\_\_\_\_ s      **1**

- (b) Using collision theory, explain why increasing the number of rhubarb cubes increases the rate of reaction.

\_\_\_\_\_  
\_\_\_\_\_  
\_\_\_\_\_ **1**



Marks

**12. (continued)**

- (c) The equation for the reaction between permanganate solution and the oxalic acid in rhubarb is

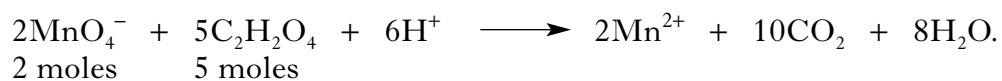

- (i) Calculate the number of moles of permanganate ions ( $\text{MnO}_4^-$ ) in  $100 \text{ cm}^3$  of a  $1.0 \text{ mol l}^{-1}$  solution.

\_\_\_\_\_ mol     **1**

- (ii) The above equation shows that 2 moles of permanganate ions react with 5 moles of oxalic acid.

How many moles of oxalic acid ( $\text{C}_2\text{H}_2\text{O}_4$ ) react with  $100 \text{ cm}^3$  of  $1.0 \text{ mol l}^{-1}$  permanganate ( $\text{MnO}_4^-$ ) solution?

\_\_\_\_\_ mol     **1**  
**(4)**

**[Turn over**

Marks

13. Part of a student's PPA sheet is shown.

Intermediate 2 Chemistry	Preparation of a Salt	Unit 3 PPA1
<p><b>Aim</b></p> <p>The aim of this experiment is to make a magnesium salt by the reaction of magnesium/magnesium carbonate with sulphuric acid.</p> <p><b>Procedure</b></p> <ol style="list-style-type: none"><li>Using a measuring cylinder add 20 cm<sup>3</sup> of dilute acid to the beaker.</li><li>Add a spatulaful of magnesium or magnesium carbonate to the acid and stir the reaction mixture with a glass rod.</li><li>If all the solid reacts add another spatulaful of magnesium or magnesium carbonate and stir the mixture.</li><li>Continue adding the magnesium or magnesium carbonate until . . .</li></ol>		

- (a) Complete the instruction for step 4 of the procedure.

---

---

---

1

- (b) Why is an excess of magnesium or magnesium carbonate added to the acid?

---

---

---

1

- (c) The equation for the preparation of magnesium sulphate from magnesium carbonate is shown.



Complete the equation showing the formulae for the missing products.

1

(3)

Marks

14. When iron reacts with water and oxygen, rust forms.

The chemical name for rust is iron(III) oxide.

(a) Write the chemical formula for rust.

\_\_\_\_\_

1

(b) During rusting, iron initially loses 2 electrons to form iron(II) ions. These are further oxidised to form iron(III) ions.

Write the ion-electron equation to show iron(II) ions forming iron(III) ions.

(You may wish to use page 7 of the data booklet to help you.)

\_\_\_\_\_

1

(c) Some iron railings were fixed into stone walls by using plugs of lead. Over time, the iron railings rusted faster at the point of contact with the lead.

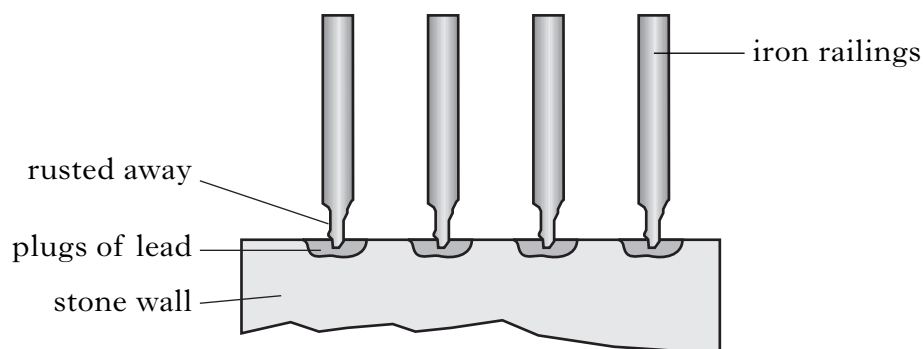

Why does lead increase the rate of rusting?

\_\_\_\_\_

\_\_\_\_\_

1

(3)

[Turn over

Marks

15. The reaction between sodium hydroxide solution and dilute sulphuric acid can be followed by measuring the conductivity of the reaction mixture.

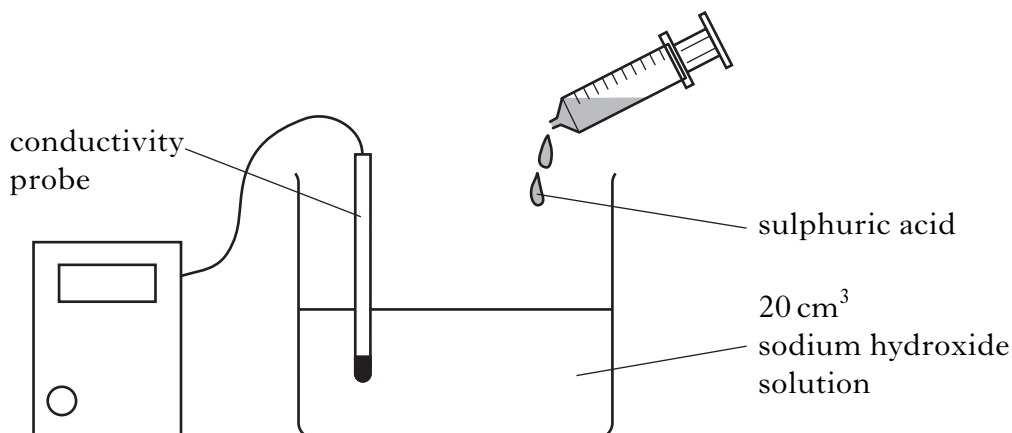

The conductivity probe measures the conductivity of the solution as the reaction proceeds.

- (a) The equation for the reaction is shown.

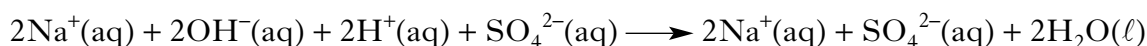

Rewrite the equation omitting the spectator ions.

1

- (b) The experiment was repeated using 20 cm<sup>3</sup> barium hydroxide solution.

The results of both experiments are shown in the table.

Solution	Conductivity at start (mA)	Conductivity at end-point (mA)
0.1 mol l <sup>-1</sup> NaOH(aq)	80	35
0.1 mol l <sup>-1</sup> Ba(OH) <sub>2</sub> (aq)	160	0

- (i) Why does barium hydroxide solution have a higher conductivity than the sodium hydroxide solution at the start?

---



---

1

Marks

**15. (b) (continued)**

The equation for the reaction between barium hydroxide solution and sulphuric acid is shown.



(ii) Why is the conductivity reading at the end point 0 mA?

---

---

**1**  
**(3)**

[END OF QUESTION PAPER]

**ADDITIONAL SPACE FOR ANSWERS**

ADDITIONAL GRAPH PAPER FOR QUESTION 3(b)(i)

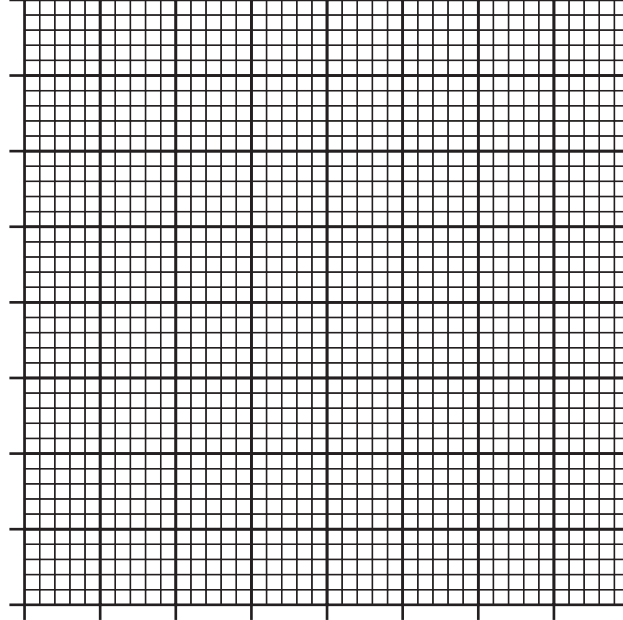

**ADDITIONAL SPACE FOR ANSWERS**

--

**ADDITIONAL SPACE FOR ANSWERS**

--